

Leica DM ILM

Inverted Microscope for Material Control

Living up to Life

Leica
MICROSYSTEMS

Leica DM ILM

The Leica DM ILM is specially designed for all inspection and measurement tasks in metallography and material testing in general, for inspection of incoming materials, production control, checking sample preparation processes and also for metallographic training.

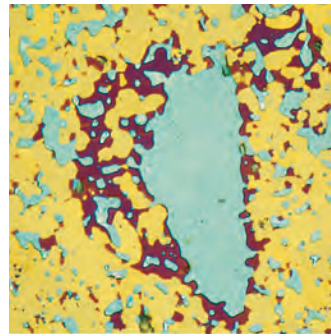

Molybdenum-silicon material

Do you need a task-oriented and cost-effective microscope?

If so, the Leica DM ILM is just what you're looking for.

Besides being easy to use, it is highly efficient and versatile – although it accommodates samples of all sizes, it has a slender footprint.

High performance optics from the Leica HC family of optics guarantee maximum image resolution and contrast.

The new HC objective series is a further development of Leica's famous Plan and Delta infinity optics.

The continuity of Leica infinity optics is a practical advantage that our customers soon come to appreciate.

The basic stand

is made of sturdy, corrosion-resistant cast aluminium with a pleasantly light paint finish and clean, smooth surfaces.

The microscope's basic T-shape provides high stability and ample space for hand movement and easy access to the controls. The microscope's base with vibration damping feet prevents the transfer of vibrations and guarantees a steady image even at high magnifications and with heavy samples.

Built-in 6 V 35 W power supply

The built-in power supply is an ergonomic feature which saves a lot of space on the workdesk. There is no clutter of cables and the microscope can easily be moved to another table as a single unit.

Also, the stand has a bayonet mount interchange for externally powered lamphousings with 12 V 100 W halogen or Hg 50/100 W and Xe 75 W gas discharge lamps. On request, two lamp-housings can also be fitted simultaneously, e.g. for brightfield and fluorescence work.

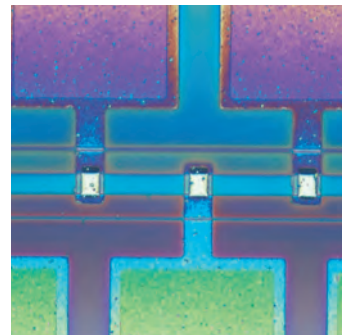

IC chip



Leica DM ILM illuminator



Leica DM ILM, tube rotated to the side

Incident light system

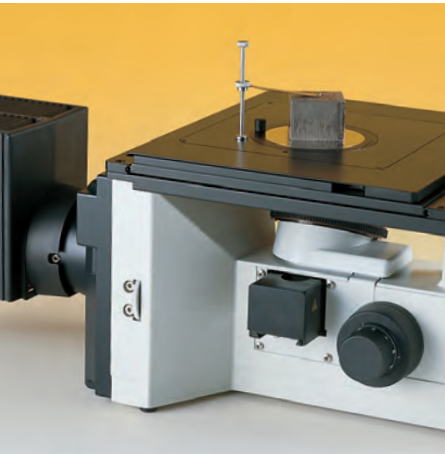

Central part of the microscope, view from the left side



Central part of the microscope, view from the right side



Central part of the microscope with quadruple objective nosepiece, reflector slide, focus control

Incident light system with new illumination principle

The new illumination axis accepts different types of light sources (lamp filament or discharge arc), ensuring an optimal light flux of maximum intensity and homogeneity. The field and aperture diaphragms are arranged in accordance with the proven Koehler principle. As the field diaphragm is preadjusted to a fixed optimal setting, there is no risk of a mix-up when centering the aperture diaphragm, which is responsible for resolution, contrast and field depth.

The incident light reflectors are enclosed in the 3-position reflector slide, where they are easily exchanged as necessary.

Light filters

Two permanently integrated positions for filters of 32 mm diameter in the microscope stand, plus an optional intermediate piece for other filters of 50 mm diameter allow specific optimization of the illumination for observation and image documentation.

3-plate mechanical stage

for samples of differing shapes and sizes. Before material defects can be detected, the interesting parts of the material must be accessible. From small to large, the 3-plate mechanical stage can accept nearly all sample sizes and also allows non-destructive microscopic examination of large components.

The large stage surface of 247 x 230 mm easily accommodates wide and tall components, and for bulky samples, the inner rectangular stage insert of 150 x 150 mm can be completely removed. Small samples are placed on the inner insets which have holes of 80 mm, 40 mm, 30 mm and 20 mm. These are optionally available with knobs for removing or rotating the sample.

High load bearing capacity – wide adjustment range

The two-sided, large stage support on the basic stand bears sample weights of up to 8 kg.

The wide adjustment range of 60 x 40 mm in x-y direction allows swift scanning and fast access to the interesting, important parts of the sample.

Nosepiece focusing – reliable and precise

Samples are focused by vertical adjustment of the 4-position objective nosepiece and the objectives used. Focusing precision is not influenced by the weight of the stage and the sample.

The optics

The optics are the heart of a microscope and decisive for the quality of the information. Designed for incident light bright-field, polarization contrast and fluorescence, the Leica DM ILM microscope is compatible with all infinity high performance objectives in the Leica range with M25 mm or RMS thread. Even earlier types of Leica (Leitz) objectives with RMS thread can be adapted for use on the Leica DM ILM.

N PLAN series

| | | FWD |
|--------|-----------|---------|
| N PLAN | 2.5x/0.07 | 11.2 mm |
| N PLAN | 5x/0.12 | 14.0 mm |
| N PLAN | 10x/0.25 | 5.8 mm |
| N PLAN | 20x/0.40 | 1.1 mm |
| N PLAN | 50x/0.75 | 0.37 mm |
| N PLAN | 100x/0.90 | 0.27 mm |

PL FLUOTAR series

| | | |
|---------------|-------------------|---------|
| PL FLUOTAR | 1.6x/0.05 | 1.54 mm |
| PL FLUOTAR | 2.5x/0.07 | 9.2 mm |
| HC PL FLUOTAR | 5x/0.15 | 12.0 mm |
| HC PL FLUOTAR | 10x/0.30 | 11.0 mm |
| HC PL FLUOTAR | 20x/0.50 | 1.27 mm |
| HC PL FLUOTAR | 50x/0.80 | 0.5 mm |
| HC PL FLUOTAR | 100x/0.90 | 0.3 mm |
| HC PL FLUOTAR | 100x/1.30 OIL ∞/0 | 0.13 mm |

PL APO series

| | | |
|-------------------------|-----------|---------|
| PL APO | 50x/0.90 | 0.28 mm |
| PL APO | 100x/0.95 | 0.16 mm |
| PL APO | 150x/0.95 | 0.20 mm |
| PL APO | 250x/0.95 | 0.24 mm |
| with spacer ring 25/RMS | | |

Objectives with long free working distances

| | | |
|-------------------------|-------------|---------|
| PL FLUOTAR | L 50x/0.55 | 8.0 mm |
| PL FLUOTAR | L 100x/0.75 | 4.7 mm |
| with spacer ring 25/RMS | | |
| PLAN H | 20x/0.40 | 12.6 mm |
| PLAN H | 40x/0.60 | 7.1 mm |



Depending on the tube, the following eyepieces are available for pin-sharp definition at the edge of the images and standard magnification:

With tubes ILB and ILT: eyepieces of 23.2 mm diameter

Eyepiece 10x/18  and eyepiece 10x/18  M (for graticules)

Eyepiece 10x/20  and eyepiece 10x/20  M (for graticules)

With tubes of the HCL series: eyepieces of 30 mm diameter

Eyepieces HC PLAN 10x/20  and eyepiece 10x/20  M

Outside the standard magnification, other eyepiece magnifications such as 12.5x, 16x and 25x are compatible.

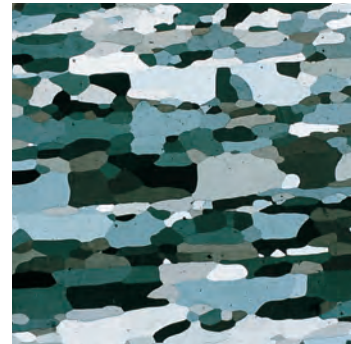

Aluminium, Pol contrast

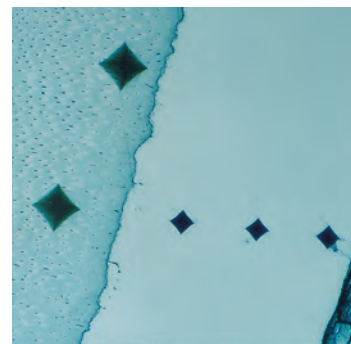

Microhardness indentations



Objective series N PLAN and PL FLUOTAR
Eyepieces 23.2 mm and 30 mm Ø

Tubes and accessories



Binocular tube HC ILB



Trinocular tube HC ILT
with Leica DFC digital camera



Trinocular tube HC ILT
with SLR camera

Observation and phototubes

The DM ILM has a wide selection of observation and phototubes for image documentation, including a tube with variable viewing angle from 0° to 35°. All the tubes are equipped with an infinity tube lens 1x and are rotatable through 360°, so that the microscope can also be used from the side. The following tubes are available:

Binocular tube HC ILB

with 45° viewing angle,
for eyepieces with 23.2 mm outer diameter

Trinocular tube HC ILT

with 45° viewing angle,
for eyepieces with 23.2 mm outer diameter with vertical photo/TV exit at the side with switchable light path 100 % vis/100 % photo/TV. The position of the photo/TV exit 88 mm to the side of the tube has the advantage of not obstructing the view of the stage and specimen.

Other tubes can be adapted with the intermediate piece IL/L:

Binocular tube HC LB

Trinocular tube HC LVB

with variable viewing angle 0° – 35°

Trinocular tube HC L1 T

light path 50 % vis/50 % photo/TV

Trinocular tube HC L3 T

light path 100 % vis/100 % photo/TV and 50 %/50 %

Trinocular tube HC LV1T

with variable viewing angle 0° – 35° and
light path 50 % vis/50 % photo/TV

Accessory systems

(for DML tube series)

Ergomodule

for raising the viewing position by 30 mm.

Magnification changer

with factors 1x, 1.5x, 2x in turret plate, for stepwise alteration of the total magnification without changing the objective.

Digital documentation and dimensions

Digital image documentation

With the specially optimized digital cameras for materials analysis (such as the Leica DFC295 or DFC450) and the Leica Application Suite LAS, you can organize your workflow – preparing specimens, examining them under the microscope and finally documenting the results – in an efficient and convenient manner.

Quick and perfect image archiving and analysis

The Leica QWin image processing and analysis software provides you with high-quality solutions, particularly in environments that require high specimen throughput and automated operation. Thanks to its modular structure, the functionality ranges from simple, interactive to automated photogrammetry, for example, characterizing metal surfaces or particle analysis (QClean).

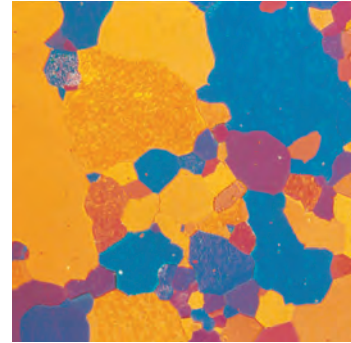

Zircon, pol contrast

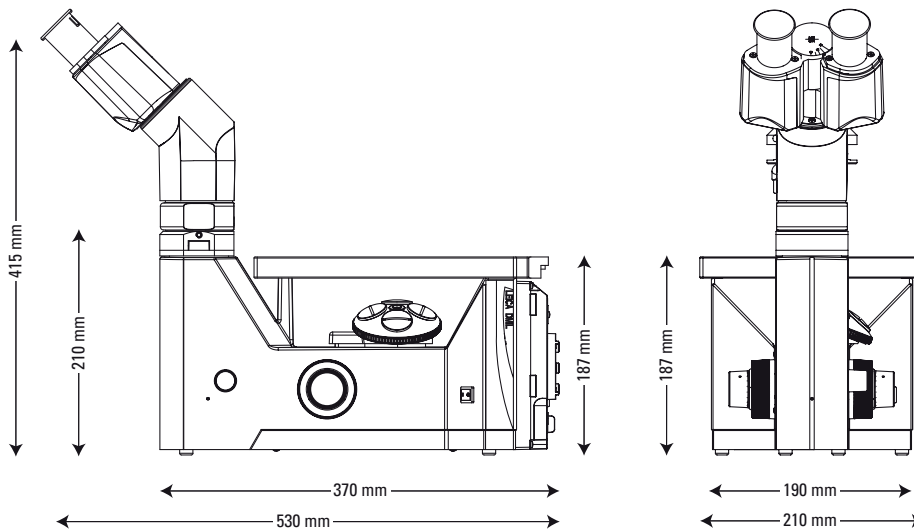

Viewing height:

| | |
|--------------------------|--------------|
| with ILB/ILT tubes | 390 mm |
| with HC L tubes | 410 mm |
| with HC L V tubes (ergo) | 350 – 450 mm |

Size of microscope:

| | |
|--------------------------------|--------|
| Front-to-back with lamphousing | 650 mm |
| Width (max.) | 320 mm |

Objective thread:

M25 x 0.75

Eyepiece diameter:

23.2 mm (ILB/ILT tubes)
30 mm (HC L tubes)

Filter diameter:

32 mm (50 mm optional)

“With the user, for the user”

Leica Microsystems

Leica Microsystems operates globally in four divisions, where we rank with the market leaders.

• Life Science Division

The Leica Microsystems Life Science Division supports the imaging needs of the scientific community with advanced innovation and technical expertise for the visualization, measurement, and analysis of microstructures. Our strong focus on understanding scientific applications puts Leica Microsystems' customers at the leading edge of science.

• Industry Division

The Leica Microsystems Industry Division's focus is to support customers' pursuit of the highest quality end result. Leica Microsystems provide the best and most innovative imaging systems to see, measure, and analyze the microstructures in routine and research industrial applications, materials science, quality control, forensic science investigation, and educational applications.

• Biosystems Division

The Leica Microsystems Biosystems Division brings histopathology labs and researchers the highest-quality, most comprehensive product range. From patient to pathologist, the range includes the ideal product for each histology step and high-productivity workflow solutions for the entire lab. With complete histology systems featuring innovative automation and Novocastra™ reagents, Leica Microsystems creates better patient care through rapid turnaround, diagnostic confidence, and close customer collaboration.

• Medical Division

The Leica Microsystems Medical Division's focus is to partner with and support surgeons and their care of patients with the highest-quality, most innovative surgical microscope technology today and into the future.

The statement by Ernst Leitz in 1907, “with the user, for the user,” describes the fruitful collaboration with end users and driving force of innovation at Leica Microsystems. We have developed five brand values to live up to this tradition: Pioneering, High-end Quality, Team Spirit, Dedication to Science, and Continuous Improvement. For us, living up to these values means: **Living up to Life.**

Active worldwide

| | | | |
|-------------------------|------------------------|-------------------------|------------------------|
| Australia: | North Ryde | Tel. +61 2 8870 3500 | Fax +61 2 9878 1055 |
| Austria: | Vienna | Tel. +43 1 486 80 50 0 | Fax +43 1 486 80 50 30 |
| Belgium: | Groot Bijgaarden | Tel. +32 2 790 98 50 | Fax +32 2 790 98 68 |
| Canada: | Concord/Ontario | Tel. +1 800 248 0123 | Fax +1 847 236 3009 |
| Denmark: | Ballerup | Tel. +45 4454 0101 | Fax +45 4454 0111 |
| France: | Nanterre Cedex | Tel. +33 811 000 664 | Fax +33 1 56 05 23 23 |
| Germany: | Wetzlar | Tel. +49 64 41 29 40 00 | Fax +49 64 41 29 41 55 |
| Italy: | Milan | Tel. +39 02 574 861 | Fax +39 02 574 03392 |
| Japan: | Tokyo | Tel. +81 3 5421 2800 | Fax +81 3 5421 2896 |
| Korea: | Seoul | Tel. +82 2 514 65 43 | Fax +82 2 514 65 48 |
| Netherlands: | Rijswijk | Tel. +31 70 4132 100 | Fax +31 70 4132 109 |
| People's Rep. of China: | Hong Kong | Tel. +852 2564 6699 | Fax +852 2564 4163 |
| | Shanghai | Tel. +86 21 6387 6606 | Fax +86 21 6387 6698 |
| Portugal: | Lisbon | Tel. +351 21 388 9112 | Fax +351 21 385 4668 |
| Singapore | | Tel. +65 6779 7823 | Fax +65 6773 0628 |
| Spain: | Barcelona | Tel. +34 93 494 95 30 | Fax +34 93 494 95 32 |
| Sweden: | Kista | Tel. +46 8 625 45 45 | Fax +46 8 625 45 10 |
| Switzerland: | Heerbrugg | Tel. +41 71 726 34 34 | Fax +41 71 726 34 44 |
| United Kingdom: | Milton Keynes | Tel. +44 800 298 2344 | Fax +44 1908 246312 |
| USA: | Buffalo Grove/Illinois | Tel. +1 800 248 0123 | Fax +1 847 236 3009 |

and representatives in more than 100 countries